



# PRODUCT SPECIFICATION

## MPO/MTP FANOUT PATCH CORD

Author	Auditor	Approver

### MPO/MTP 0.9mm FANOUT DIAGRAM (WITHOUT BRANCHING DEVICE)

### MPO/MTP COMMON FANOUT CHANNEL DIAGRAM

0.9mm Fanout with equal length

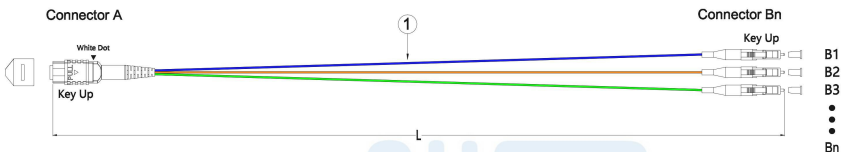

0.9mm Fanout with unequal length

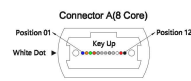
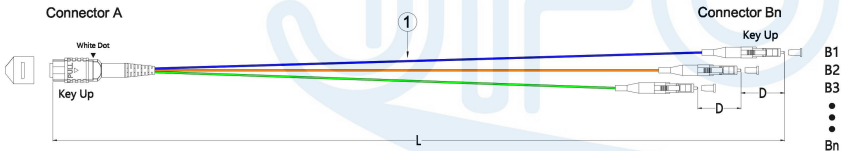

**8 Core**

Connector A Position	01	02	03	04	05	06	07	08	09	10	11	12
Channel	Blue	Orange	Green	Brown	/	/	/	/	Gray	White	Red	Black
Connector Bn	B1	B2	B3	B4	/	/	/	/	B5	B6	B7	B8



**12 Core**

Connector A Position	01	02	03	04	05	06	07	08	09	10	11	12
Channel	Blue	Orange	Green	Brown	Gray	White	Red	Black	Yellow	Purple	Pink	Aqua
Connector Bn	B1	B2	B3	B4	B5	B6	B7	B8	B9	B10	B11	B12

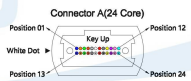

**24 Core**

Connector A Position	01	02	03	04	05	06	07	08	09	10	11	12	13	14	15	16	17	18	19	20	21	22	23	24
Channel	Blue	Orange	Green	Brown	Gray	White	Red	Black	Yellow	Purple	Pink	Aqua	Blue	Orange	Green	Brown	Gray	White	Red	Black	Yellow	Purple	Pink	Aqua
Connector Bn	B1	B2	B3	B4	B5	B6	B7	B8	B9	B10	B11	B12	B13	B14	B15	B16	B17	B18	B19	B20	B21	B22	B23	B24

POS.	Description	Specification	Q.ty
1	Empty tube	0.9 mm color empty tubes	N

Length tolerance table	
Grade	Tolerance range(cm)
I	0 ≤ X ≤ 6.0

\* Different types of patch cord will have different components.  
Please consult our company for details.

**JFOPT® JFOPT CO.,LTD.**

Product Name	MPO/MTP Fanout Patch Cord	Product Coding	
Design		Material	Date
Review		Unit	mm
Approval		Scale	Edition
			Visual

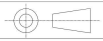

### MPO/MTP 0.9mm FANOUT DIAGRAM (WITHIN BRANCHING DEVICE)

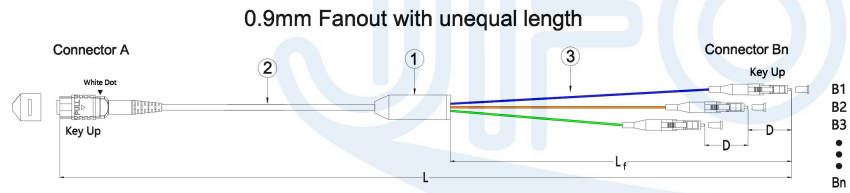
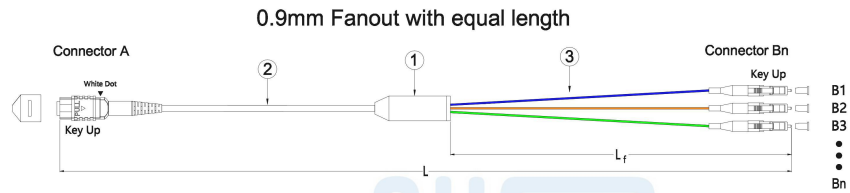

POS.	Description	Specification	Q.ty
1	Branching device	Ribbon/Miniature Branching device	1
2	Cable	Ribbon/Miniature	1
3	Empty tube	0.9 mm color empty tubes	N

Length tolerance table	
Grade	Tolerance range(cm)
I	0 ≤ X ≤ 6.0

\* Different types of patch cord will have different components.  
Please consult our company for details.

### MPO/MTP COMMON FANOUT CHANNEL DIAGRAM

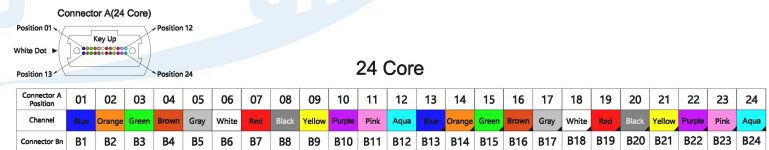

**JFOPT® JFOPT CO.,LTD.**

Product Name	MPO/MTP Fanout Patch Cord	Product Coding	
Design		Material	Date
Review		Unit	mm
Approval		Scale	Visual



### MPO/MTP 2.0/3.0mm FANOUT DIAGRAM (WITHIN BRANCHING DEVICE)

#### 2.0/3.0mm Fanout with equal length

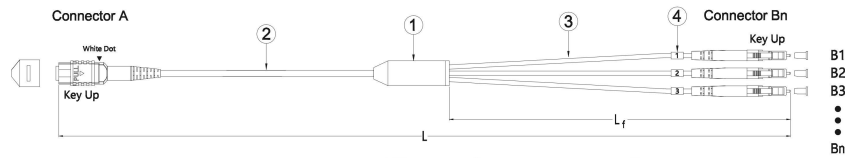

#### 2.0/3.0mm Fanout with unequal length

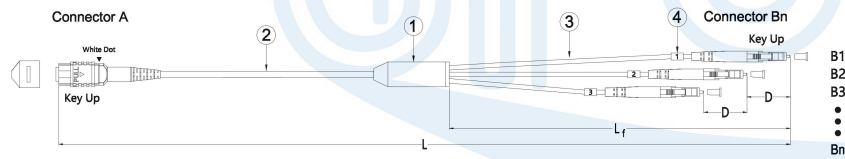

#### Branching device

POS.	Description	Specification	Q.ty
1	Branching device	Ribbon/Miniature Branching device	1
2	Cable	Ribbon/Miniature	1
3	Empty tube	2.0/3.0 mm	N
4	Cable marker	Cable marker tube	N

Length tolerance table	
Grade	Tolerance range(cm)
I	0 ≤ X ≤ 6.0

\* Different types of patch cord will have different components.  
Please consult our company for details.

### MPO/MTP COMMON FANOUT CHANNEL DIAGRAM

#### 8 Core

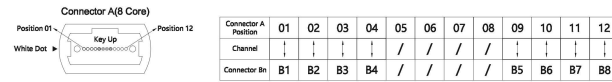

#### 12 Core

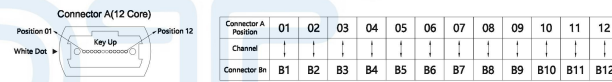

#### 24 Core

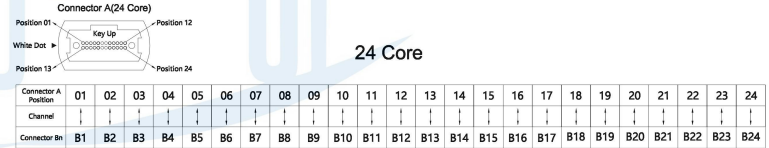

**JFOPT® JFOPT CO.,LTD.**

Product Name	MPO/MTP Fanout Patch Cord	Product Coding			
Design		Material		Date	
Review		Unit	mm	Edition	A
Approval		Scale		Visual	

# Type A

## MPO/MTP 2.0/3.0mm FANOUT DIAGRAM (WITHIN BRANCHING DEVICE)

### 2.0/3.0mm Fanout with equal length

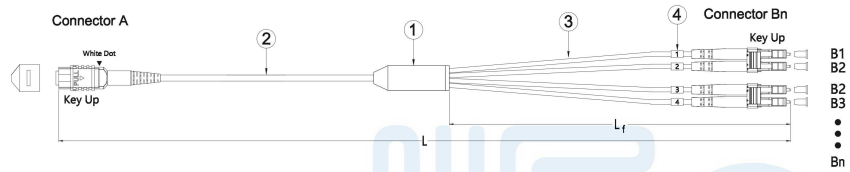

### 2.0/3.0mm Fanout with unequal length

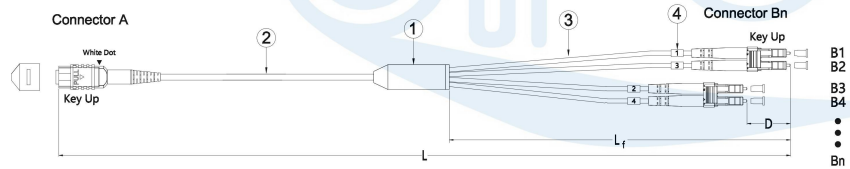

## MPO/MTP COMMON FANOUT CHANNEL DIAGRAM

### 8 Core

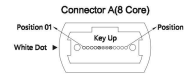

Connector A Position	01	02	03	04	05	06	07	08	09	10	11	12
Channel	↓	↓	↓	↓	↓	↓	↓	↓	↓	↓	↓	↓
Connector Bn	B1	B2	B3	B4	/	/	/	/	B5	B6	B7	B8

### 12 Core



Connector A Position	01	02	03	04	05	06	07	08	09	10	11	12
Channel	↓	↓	↓	↓	↓	↓	↓	↓	↓	↓	↓	↓
Connector Bn	B1	B2	B3	B4	B5	B6	B7	B8	B9	B10	B11	B12

### 24 Core

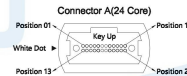

Connector A Position	01	02	03	04	05	06	07	08	09	10	11	12	13	14	15	16	17	18	19	20	21	22	23	24
Channel	↓	↓	↓	↓	↓	↓	↓	↓	↓	↓	↓	↓	↓	↓	↓	↓	↓	↓	↓	↓	↓	↓	↓	↓
Connector Bn	B1	B2	B3	B4	B5	B6	B7	B8	B9	B10	B11	B12	B13	B14	B15	B16	B17	B18	B19	B20	B21	B22	B23	B24

### Branching device

POS.	Description	Specification	Q.ty
1	Branching device	Ribbon/Miniature Branching device	1
2	Cable	Ribbon/Miniature	1
3	Empty tube	2.0/3.0 mm	N
4	Cable marker	Cable marker tube	N

### Length tolerance table

Grade	Tolerance range(cm)
I	0 ≤ X ≤ 6.0

\* Different types of patch cord will have different components.  
Please consult our company for details.

**JFOPT® JFOPT CO.,LTD.**

Product Name	MPO/MTP DX Fanout Patch Cord(Type A)			Product Coding	
Design		Material		Date	
Review		Unit	mm	Edition	A
Approval		Scale		Visual	

# Type B

## MPO/MTP 2.0/3.0mm FANOUT DIAGRAM (WITHIN BRANCHING DEVICE)

### 2.0/3.0mm Fanout with equal length

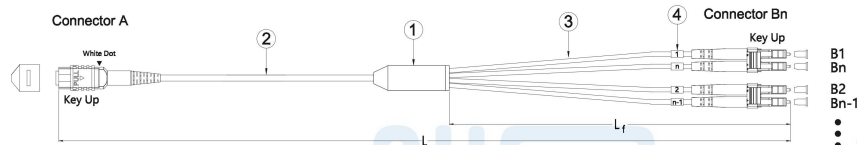

### 2.0/3.0mm Fanout with unequal length

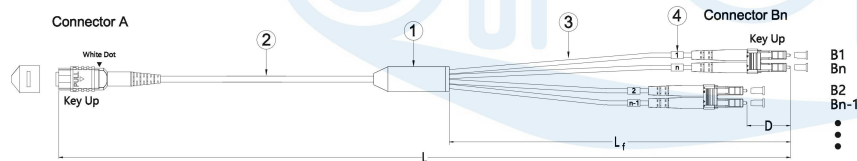

## MPO/MTP COMMON FANOUT CHANNEL DIAGRAM

### 8 Core



Connector A Position	01	02	03	04	05	06	07	08	09	10	11	12
Channel	↓	↓	↓	↓	↓	↓	↓	↓	↓	↓	↓	↓
Connector Bn	B1	B2	B3	B4	/	/	/	/	B5	B6	B7	B8

### 12 Core

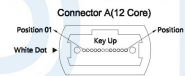

Connector A Position	01	02	03	04	05	06	07	08	09	10	11	12
Channel	↓	↓	↓	↓	↓	↓	↓	↓	↓	↓	↓	↓
Connector Bn	B1	B2	B3	B4	B5	B6	B7	B8	B9	B10	B11	B12

### 24 Core

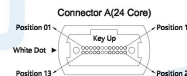

Connector A Position	01	02	03	04	05	06	07	08	09	10	11	12	13	14	15	16	17	18	19	20	21	22	23	24
Channel	↓	↓	↓	↓	↓	↓	↓	↓	↓	↓	↓	↓	↓	↓	↓	↓	↓	↓	↓	↓	↓	↓	↓	↓
Connector Bn	B1	B2	B3	B4	B5	B6	B7	B8	B9	B10	B11	B12	B13	B14	B15	B16	B17	B18	B19	B20	B21	B22	B23	B24

### Branching device

POS.	Description	Specification	Q.ty
1	Branching device	Ribbon/Miniature Branching device	1
2	Cable	Ribbon/Miniature	1
3	Empty tube	2.0/3.0 mm	N
4	Cable marker	Cable marker tube	N

### Length tolerance table

Grade	Tolerance range(cm)
I	0 ≤ X ≤ 6.0

\* Different types of patch cord will have different components.  
Please consult our company for details.

**JFOPT® JFOPT CO.,LTD.**

Product Name	MPO/MTP DX Fanout Patch Cord(Type B)	Product Coding	
Design		Material	Date
Review		Unit	mm
Approval		Scale	Visual

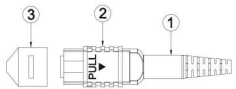

### Connector selection table

Connector A (Optional)	Description
	① MPO/MTP boot
	② MPO/MTP optical connector
	③ MPO/MTP dust cover

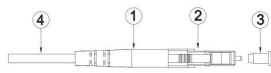
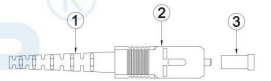
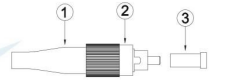
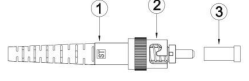
Description	Connector Bn (Optional)
Connector boot	
LC connector	
LC Dust cover	
Heat shrinkable tube (Only 2.0mm cable equipped with)	
Connector boot	
SC connector	
SC Dust cover	
Connector boot	
FC connector	
FC Dust cover	
Connector boot	
ST connector	
ST Dust cover	

\* This manual only shows four connectors of LC / SC / FC / ST, and other connectors can be customized according to this standard. Please consult our company for details.

**JFOPT® JFOPT CO.,LTD.**

Product Name	Connector	Product Coding		
Design	Material	Date		
Review	Unit	mm	Edition	A
Approval	Scale	Visual		

**Reference Standard:**

- 1.YD/T 1272.1 《Optical fiber connector part first: LC》
- 2.YD/T 1272.3 《Optical fiber connector part third: SC》
- 3.YD/T 1272.4 《Optical fiber connector part four: FC》
- 4.IEC 61753-1:2018 《Fibre optic interconnecting devices and passive components-Performance standard-Part 1: General and guidance》
- 5.IEC 61754-4:2013 《Fibre optic interconnecting devices and passive components-Fibre optic connector interfaces-Part 4: Type SC connector family》
- 6.IEC 61754-13:2006 《Fibre optic connector interfaces - Part 13: Type FC-PC connector》
- 7.IEC 61754-20:2012 《Fibre optic interconnecting devices and passive components - Fibre optic connector interfaces - Part 20: Type LC connector family》
- 8.IEC 61754-20-100:2012 《Fibre optic interconnecting devices and passive components - Fibre optic connector interfaces - Part 20-100: Interface standard for LC connectors with protective housings related to IEC 61076-3-106》
- 9.IEC 61754-7-1:2014 《Fibre optic interconnecting devices and passive components - Fibre optic connector interfaces - Part 7-1: Type MPO connector family - One fibre row》
- 10.IEC 61754-7-2:2017 《Fibre optic interconnecting devices and passive components - Fibre optic connector interfaces - Part 7-2: Type MPO connector family - Two fibre rows》
- 11.IEC 61754-7-3:2019 《Fibre optic interconnecting devices and passive components - Fibre optic connector interfaces - Part 7-3: Type MPO connector family - Two fibre rows 16 fibre wide》
- 12.GR 1435 《Core Generic Requirements for Multi-Fiber Optical Connectors》
- 13.YD/T 1272.5 《Optical fiber connector-part 5: Type MPO》

\* Due to different product requirements and grades, Compliance with different grades and requirements of a standard may vary.Please consult our company for details.

**Reference Test Standards:**

- 1.GB/T 7424.2-2008 《Optical fibre cable generic specification-Part 2: Basic optical cable test procedures》
- 2.GB/T 7424.1-2003 《Generic specification for optical fibre cables-Part 1:General》
- 3.IEC 61300-2-17:2010 《Fibre optic interconnecting devices and passive components-Basic test and measurement procedures - Part 2-17: Tests-Cold》
- 4.IEC 61300-2-18:2005 《Fibre optic interconnecting devices and passive components-Basic test and measurement procedures - Part 2-18: Tests-Dry heat-High temperature endurance》
- 5.IIEC 61300-2-19:2012 《Fibre optic interconnecting devices and passive components-Basic test and measurement procedures-Part 2-19: Tests-Damp heat (steady state)》
- 6.IEC 61300-2-21:2009 《Fibre optic interconnecting devices and passive components-Basic test and measurement procedures-Part 2-21: Tests-Composite temperature/humidity cyclic test》
- 7.IEC 61300-2-22:2007 《Fibre optic interconnecting devices and passive components-Basic test and measurement procedures-Part 2-22: Tests-Change of temperature》
- 8.IEC 61300-3-6:2008 《Fibre optic interconnecting devices and passive components-Basic test and measurement procedures-Part 3-6: Examinations and measurements-Return loss》
- 9.IEC 61300-3-34:2009 《Fibre optic interconnecting devices and passive components-Basic test and measurement procedures-Part 3-34: Examinations and measurements-Attenuation of random mated connectors》
- 10.IEC 61300-3-45:2011 《Fibre optic interconnecting devices and passive components-Basic test and measurement procedures-Part 3-45: Examinations and measurements-Attenuation of random mated multi-fibre connectors》

**APPLICABLE CABLE**



Optical Fiber Ribbon

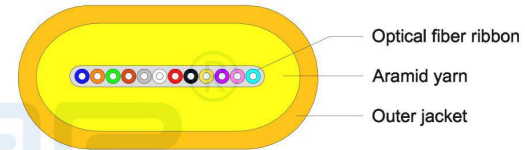

Ribbon Cable

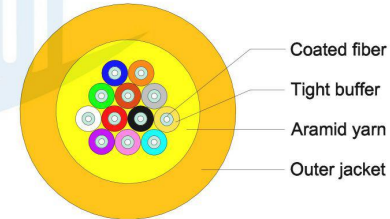

Miniature Cable

**JFOPT® JFOPT CO.,LTD.**

Product Name	Characteristics		Product Coding		
Design		Material		Date	
Review		Unit	mm	Edition	A
Approval		Scale		Visual	



End Face Requirement(Single-Mode)

Region	Scratch	Speckle	Other
Region A (0-25 $\mu$ m)	None	None	None
Region B (25-115 $\mu$ m)	No black scratches allowed, Allow two white scratches and the width $\leq$ 2 $\mu$ m.	Allow three speckle and the diameters $\leq$ 5 $\mu$ m.	No breakage and crack

End Face Requirement(Multi-Mode)

Region	Scratch	Speckle	Other
Region A (0-65 $\mu$ m)	None	None	None
Region B (65-115 $\mu$ m)	No black scratches allowed, Allow two white scratches and the width $\leq$ 2 $\mu$ m.	Allow three speckle and the diameters $\leq$ 5 $\mu$ m.	No breakage and crack

1. Inspection equipment requirements: Optical fiber end face detector more than 400 times.
2. For scratches (linear), it refers to the width; for speckles, fragments and particles (non linear), it refers to the maximum diameter; there shall be no cracks in the optical fiber area.
3. There shall be no massive piece stains, fragments, grinding residues, etc outside the contact area.
4. The removable dirt and loose particles on the end face of the insert core must be removed as far as possible. All the allowed defect connectors shall not exceed 15% of the total number.

Geometric Dimensions Requirement

Items		Max	Min
Radius of curvature (mm)	X	2000	-10000
	Y	-	5
Angle (°)	X	0.15	-0.15
	Y (APC)	8.2	7.8
	Y (PC)	0.2	-0.2
Radius of curvature of optical core (mm)	-	1	
Fiber height (nm)	3500	1000	
Height difference of adjacent fiber (nm)	500	N/A	
Maximum negative coplanar (nm)	300	N/A	

\* This item is optional.  
Please consult our company for details.

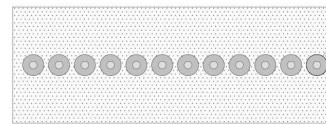
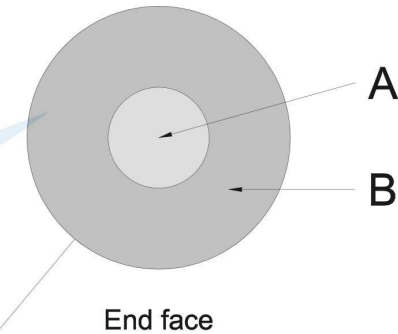

**JFOPT® JFOPT CO.,LTD.**

Product Name	end face		Product Coding	
Design	Material	Date	Edition A	
Review	Unit mm	Visual	Scale	
Approval	Scale	Visual	A	

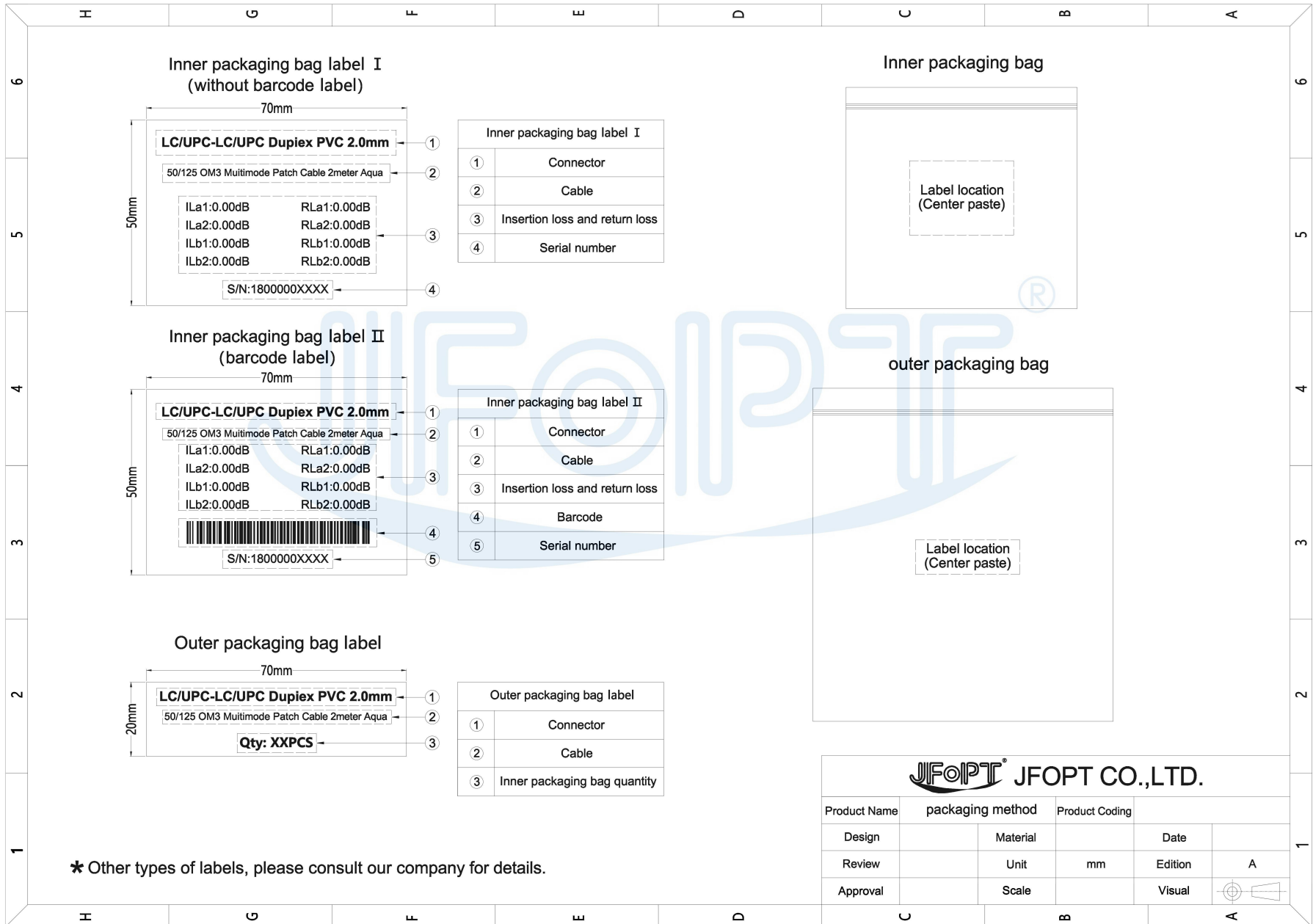

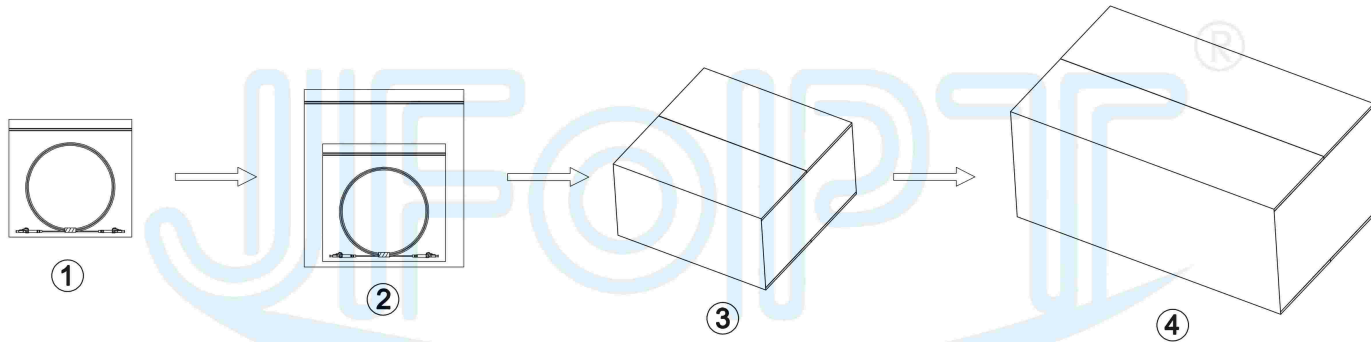

**Packaging**

- 1. Optical fiber jumper packed in Inner packaging bag.
- 2. Multiple Inner packaging bags packed in outer packaging bag.
- 3. Multiple outer packaging bags packed in inner carton.
- 4. Multiple inner cartons packed in outer carton.

\* Different types of patch cord, the packaging will be different.  
Please consult our company for details.

**JFOPT® JFOPT CO.,LTD.**

Product Name	packaging method	Product Coding		
Design		Material		Date
Review		Unit	mm	Edition
Approval		Scale		Visual

