

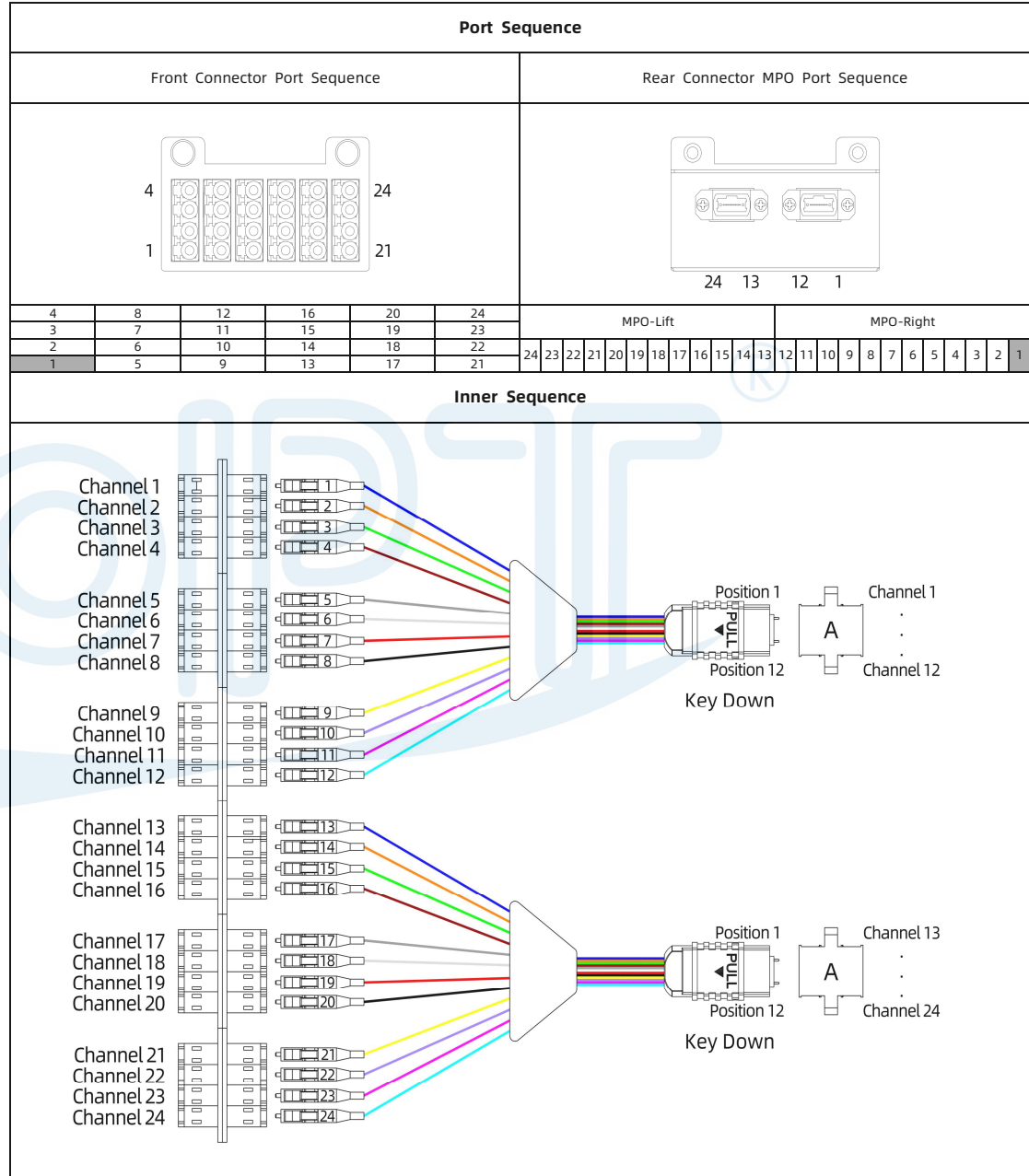

# LINEAR SPECIFICATION

## JFOPP-MPO10-A-004 MPO Cassettes

Author	Auditor	Approver

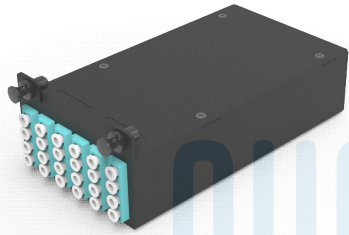

Configuration	
Fiber Count	12 × 2 Fibers
Fiber Mode	SM: OS2 9/125 μm MM: OM3 50/125 μm ; OM4 50/125 μm
Front Connector	SM: LC Connector With UPC/APC Polish MM: LC Connector With UPC Polish
Front Adapter	LC Quadplex
Rear Connector	SM: MPO/MTP Connector With Male Ferrules And PC Polish MM: MPO/MTP Connector With Male Ferrules And APC Polish
Rear Adapter	MPO/MTP Adapter The Key In Different Directions
Polarity Type	Type A

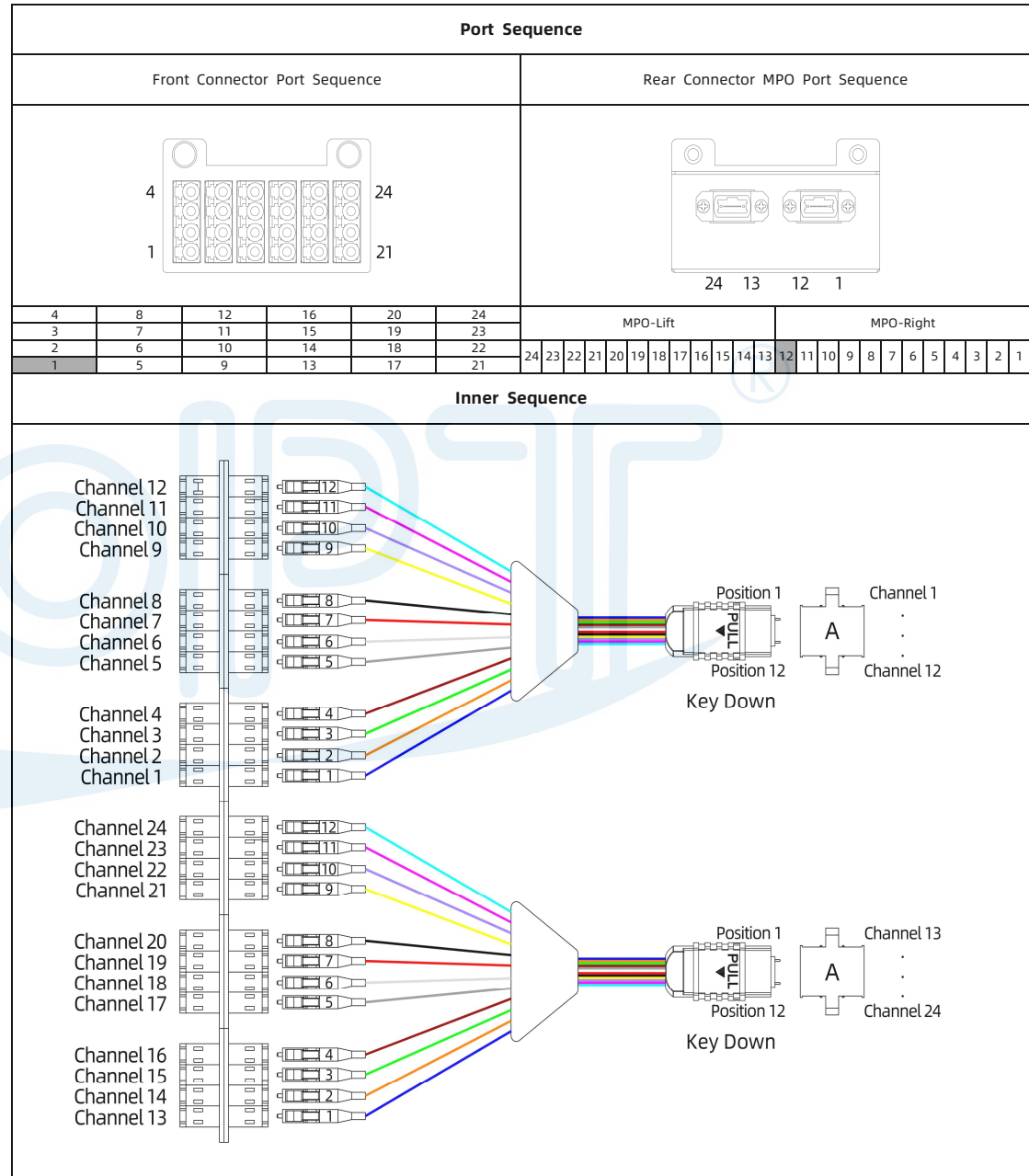
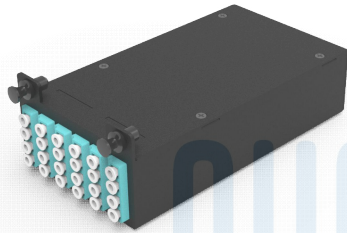

Configuration	
Fiber Count	12 × 2 Fibers
Fiber Mode	SM: OS2 9/125 μm MM: OM3 50/125 μm ; OM4 50/125 μm
Front Connector	SM: LC Connector With UPC/APC Polish MM: LC Connector With UPC Polish
Front Adapter	LC Quadplex
Rear Connector	SM: MPO/MTP Connector With Male Ferrules And PC Polish MM: MPO/MTP Connector With Male Ferrules And APC Polish
Rear Adapter	MPO/MTP Adapter The Key In Different Directions
Polarity Type	Type B

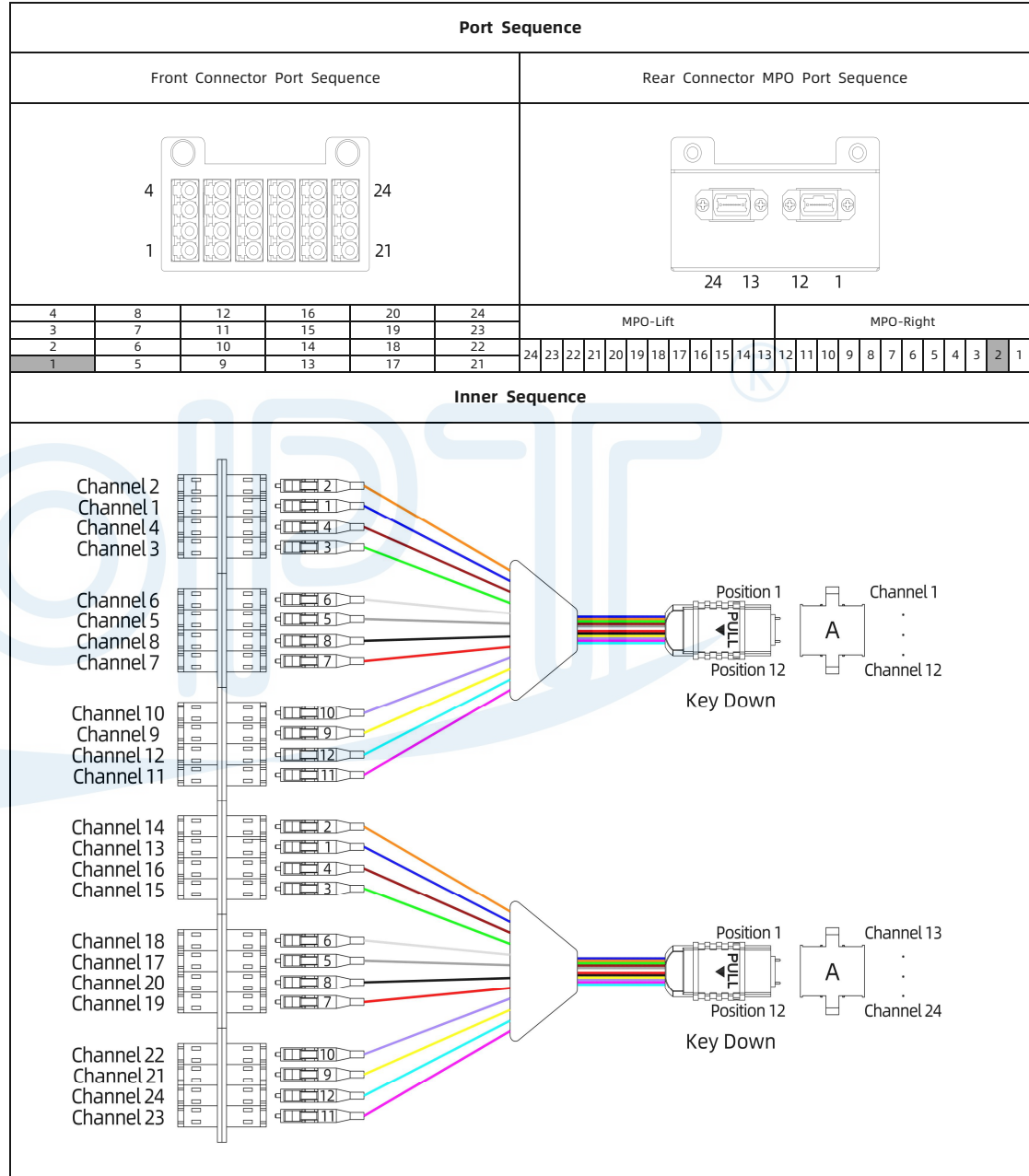
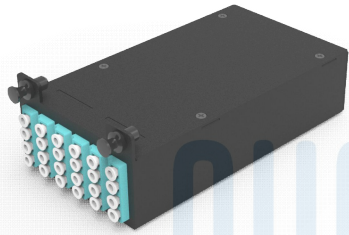

Configuration	
Fiber Count	12 × 2 Fibers
Fiber Mode	SM: OS2 9/125 μm MM: OM3 50/125 μm ; OM4 50/125 μm
Front Connector	SM: LC Connector With UPC/APC Polish MM: LC Connector With UPC Polish
Front Adapter	LC Quadplex
Rear Connector	SM: MPO/MTP Connector With Male Ferrules And PC Polish MM: MPO/MTP Connector With Male Ferrules And APC Polish
Rear Adapter	MPO/MTP Adapter The Key In Different Directions
Polarity Type	Type C

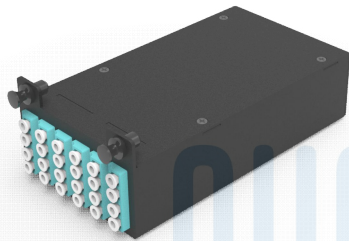

Configuration	
Fiber Count	24 × 1 Fibers
Fiber Mode	SM: OS2 9/125 μm MM: OM3 50/125 μm ; OM4 50/125 μm
Front Connector	SM: LC Connector With UPC/APC Polish MM: LC Connector With UPC Polish
Front Adapter	LC Quadplex
Rear Connector	SM: MPO/MTP Connector With Male Ferrules And PC Polish MM: MPO/MTP Connector With Male Ferrules And APC Polish
Rear Adapter	MPO/MTP Adapter The Key In Different Directions
Polarity Type	Type A

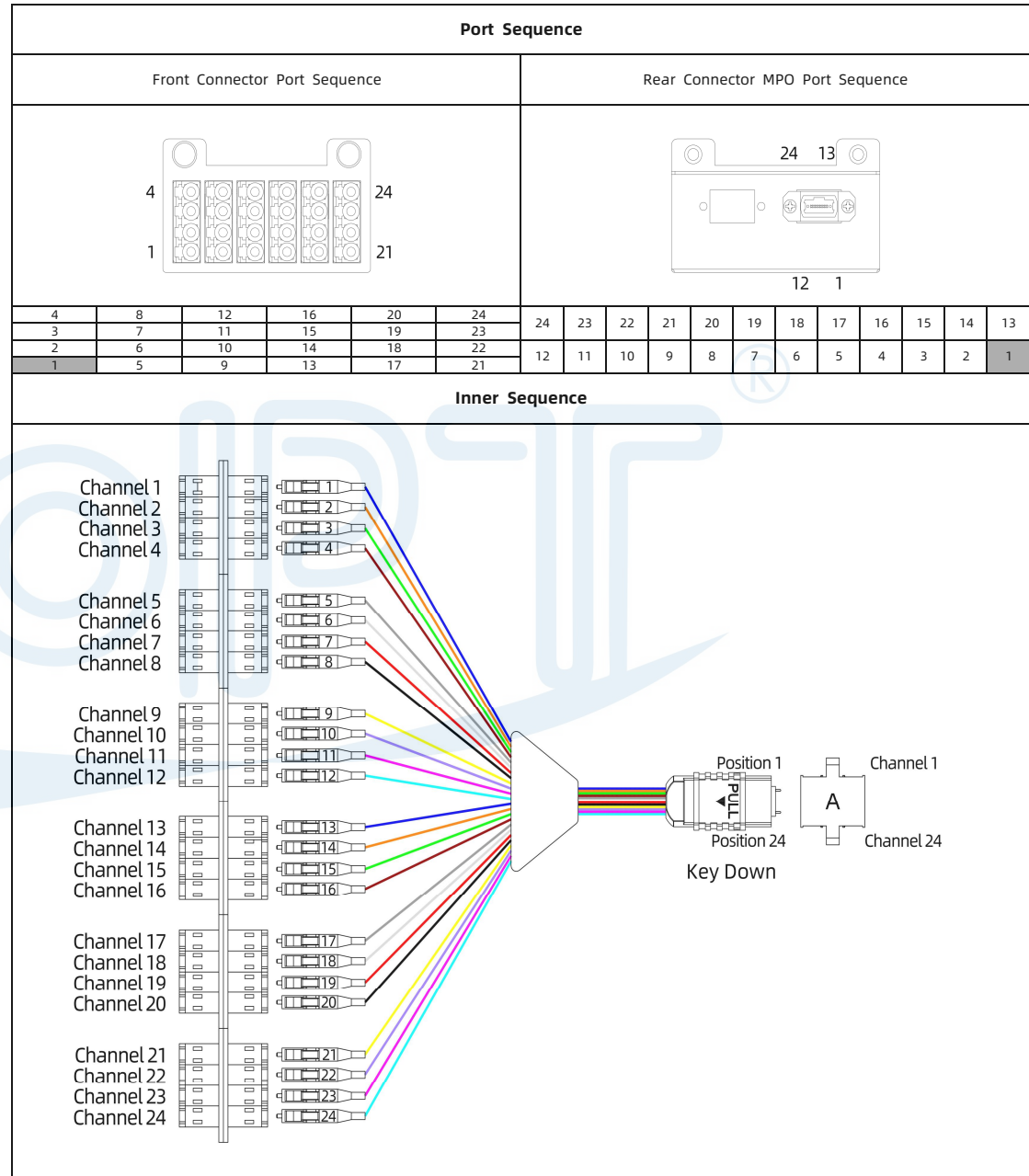

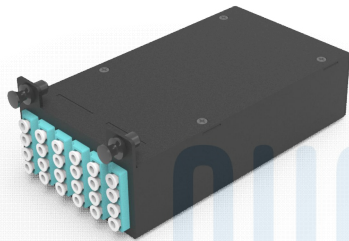

Configuration	
Fiber Count	24 × 1 Fibers
Fiber Mode	SM: OS2 9/125 μm MM: OM3 50/125 μm ; OM4 50/125 μm
Front Connector	SM: LC Connector With UPC/APC Polish MM: LC Connector With UPC Polish
Front Adapter	LC Quadplex
Rear Connector	SM: MPO/MTP Connector With Male Ferrules And PC Polish MM: MPO/MTP Connector With Male Ferrules And APC Polish
Rear Adapter	MPO/MTP Adapter The Key In Different Directions
Polarity Type	Type B

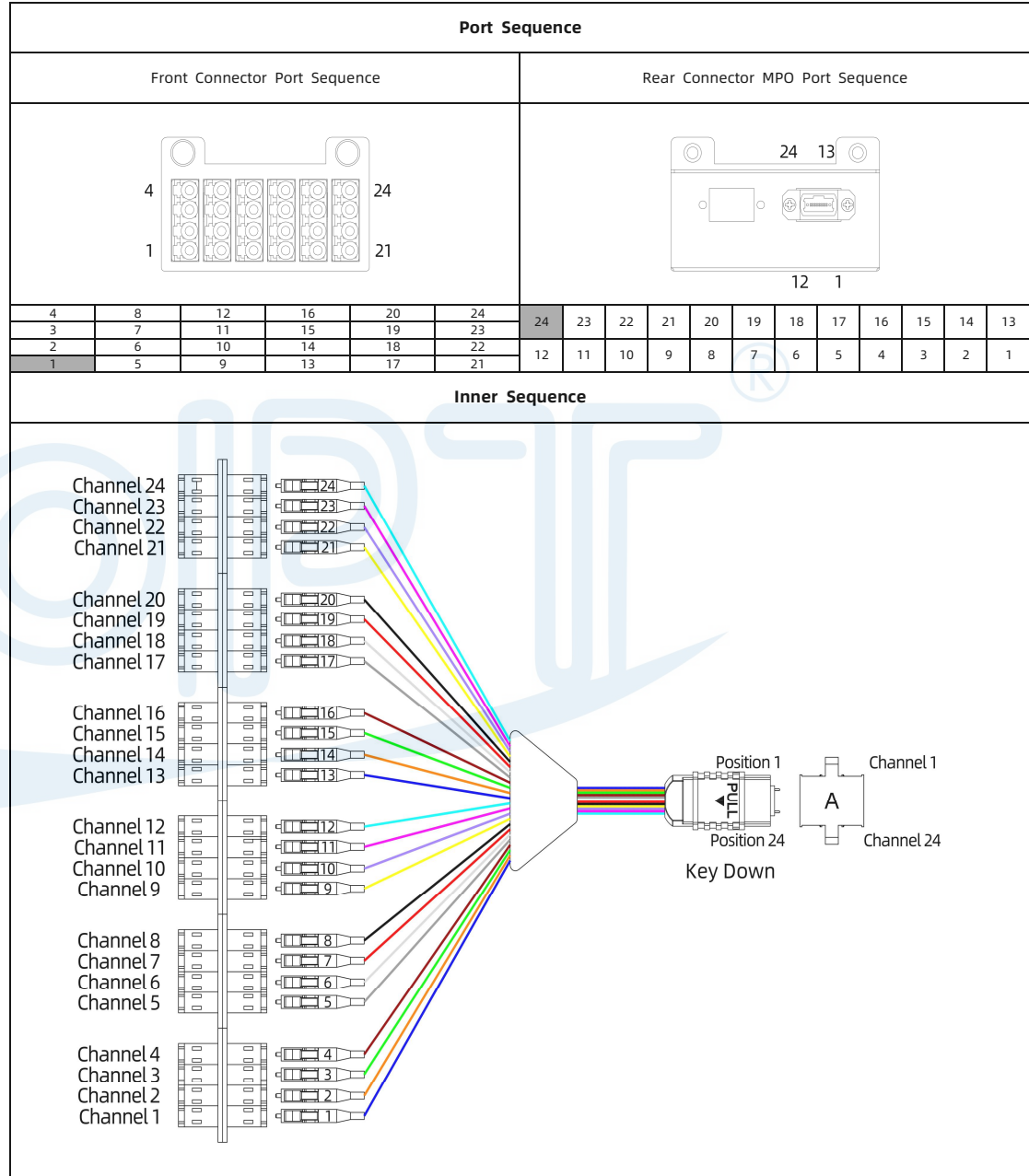

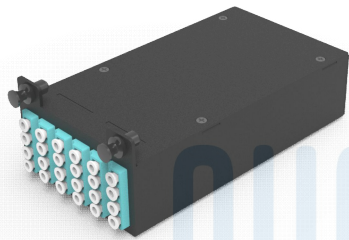

Configuration	
Fiber Count	24 × 1 Fibers
Fiber Mode	SM: OS2 9/125 μm MM: OM3 50/125 μm ; OM4 50/125 μm
Front Connector	SM: LC Connector With UPC/APC Polish MM: LC Connector With UPC Polish
Front Adapter	LC Quadplex
Rear Connector	SM: MPO/MTP Connector With Male Ferrules And PC Polish MM: MPO/MTP Connector With Male Ferrules And APC Polish
Rear Adapter	MPO/MTP Adapter The Key In Different Directions
Polarity Type	Type C

